

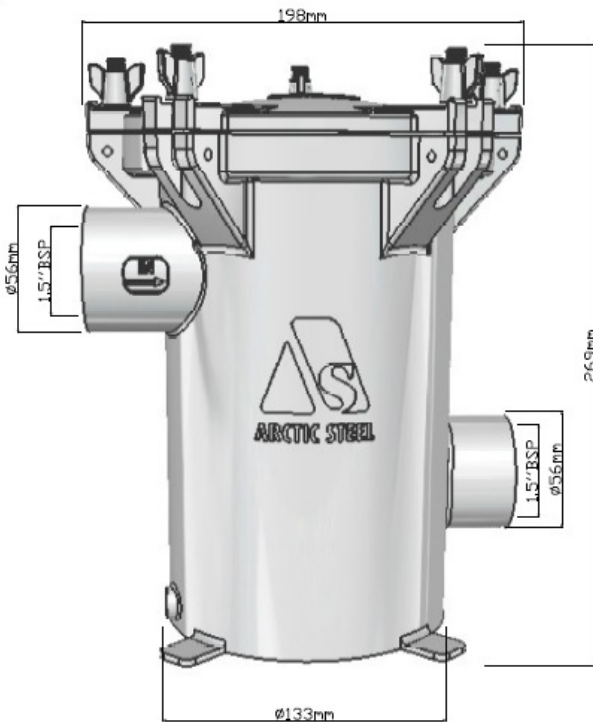

ARCTIC STEEL

STRENGTH RELIABILITY PERFORMANCE



1.5" Side In Side Out S (Solid Lid) or C (Clear Lid)

SISO strainers are free standing, base mounted.

- Electro-polished AISI 2205 Cast Stainless Steel Body
- Solid electro-polished 316 stainless steel lid
- Secured by 5 x 316 SS wing nuts for safe, quick and easy access.
- Swing down 316 SS eye bolts eliminate need to remove nuts.
- BSP or NPT thread.
- Offset side female inlet, side female outlet
- Full height, high impact resistance ABS basket.
- Optional 316 stainless basket available.
- Durable silicone gasket.
- Cast anode connection point to combat electrolysis.
- Drain plug
- Clear 8mm poly carbonate lid option available
- Designed for applications that require a header tank or mounting above the waterline.

Strainer Solid Lid Weight Kg	Strainer Clear Lid Weight Kg	Flow Rate 0.1 Bar L/Min	Flow Rate 1 Bar L/Min
6.2	6.0	193	620